

InVent™ SERIES FAN

For Warranty Statement, Service Parts, Technical Support, or to Register your product, please visit our website or call:
 In the United States - Broan.com 800-637-1453 or NuTone.com 888-336-6151
 In Canada - Broan.ca or NuTone.ca 877-896-1119

READ AND SAVE THESE INSTRUCTIONS

⚠️ WARNING

TO REDUCE THE RISK OF FIRE, ELECTRIC SHOCK, OR INJURY TO PERSONS, OBSERVE THE FOLLOWING:

1. Use this unit only in the manner intended by the manufacturer. If you have questions, contact the manufacturer at the address or telephone number listed in the warranty.
2. Before servicing or cleaning unit, switch power off at service panel and lock the service disconnecting means to prevent power from being switched on accidentally. When the service disconnecting means cannot be locked, securely fasten a prominent warning device, such as a tag, to the service panel.
3. Installation work and electrical wiring must be done by a qualified person(s) in accordance with all applicable codes and standards, including fire-rated construction codes and standards.
4. Sufficient air is needed for proper combustion and exhausting of gases through the flue (chimney) of fuel burning equipment to prevent backdrafting. Follow the heating equipment manufacturer's guideline and safety standards such as those published by the National Fire Protection Association (NFPA), and the American Society for Heating, Refrigeration and Air Conditioning Engineers (ASHRAE), and the local code authorities.
5. When cutting or drilling into wall or ceiling, do not damage electrical wiring and other hidden utilities.
6. Ducted fans must always be vented to the outdoors.
7. Acceptable for use over a tub or shower when connected to a GFCI (Ground Fault Circuit Interrupter) - protected branch circuit (ceiling installation only).
8. This unit must be grounded.

⚠️ CAUTION

1. For general ventilating use only. Do not use to exhaust hazardous or explosive materials and vapors.
2. This product can be installed in a wall if mounted 8-ft. or more above the floor.
3. To avoid motor bearing damage and noisy and/or unbalanced impellers, keep drywall spray, construction dust, etc. off power unit.
4. Please read specification label on product for further information and requirements.

CLEANING & MAINTENANCE

For quiet and efficient operation, long life, and attractive appearance - lower or remove grille and vacuum interior of unit with the dusting brush attachment.

The motor is permanently lubricated and never needs oiling. If the motor bearings are making excessive or unusual noises, replace the blower assembly (includes motor and impeller).

OPERATION

Use an on/off switch or speed control to operate this ventilator. See "Connect Wiring" for details.

ALL INSTALLATIONS Start here.

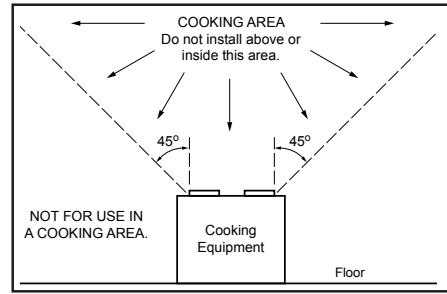

💡 **IMPORTANT** - The ducting from this fan to the outside of the building has a strong effect on the air flow, noise and energy use of the fan. Use the shortest, straightest duct routing possible for best performance, and avoid installing the fan with smaller ducts than recommended. Insulation around the ducts can reduce energy loss and inhibit mold growth. Fans installed with existing ducts may not achieve their rated airflow.

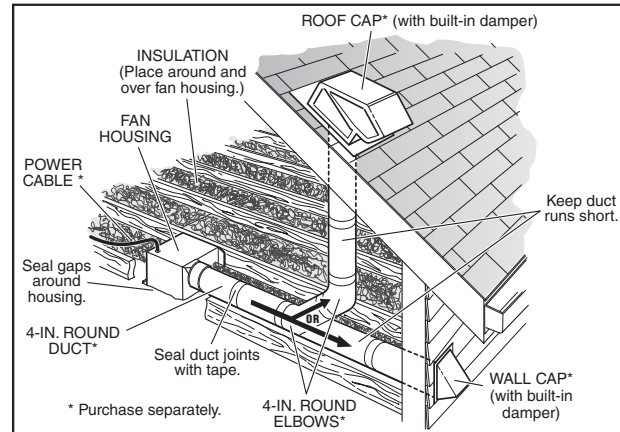

💡 **OPTION** - To mount housing anywhere between ceiling framing: Use optional Hanger Bar Kit (sold separately from local distributors or website). Follow mounting instructions included with kit.

1. Remove blower and all packing material from fan housing.

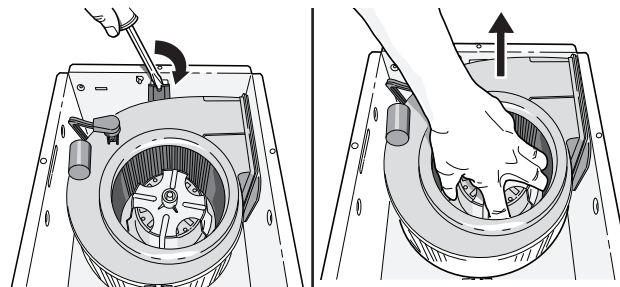

2. Remove wiring panel from fan housing.

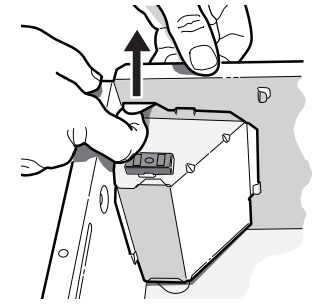

For Retrofit Installation - Skip to back page.

NEW CONSTRUCTION INSTALLATION

3. Attach damper/duct connector to fan housing.

Push connector through opening from inside of housing.
Engage tabs and secure with screw from parts bag.

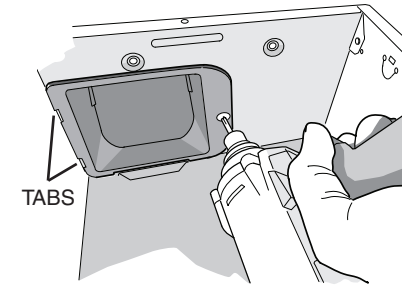

4. Mount housing to ceiling structure.

Make sure bottom of housing will be flush with finished ceiling.

For proper location using 1/2" ceiling material: Bend out housing tabs to fit against bottom of structure.

Secure housing through mounting ears with appropriate fasteners. (Some models include mounting screws.)

If mounting housing to I-joint, use wood blocking as shown.

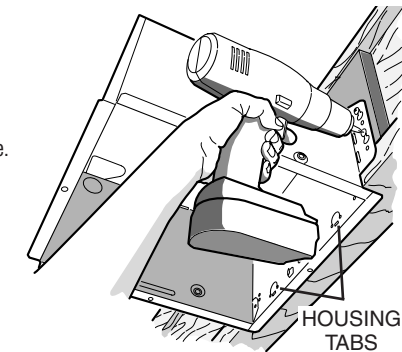

5. Connect 4-in. round duct.

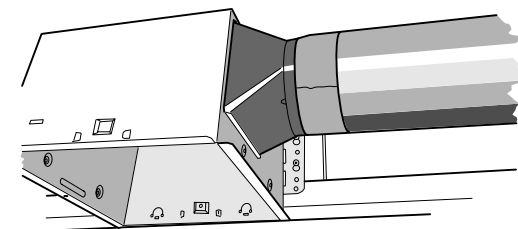

6. Connect wiring.

Bend tab to expose desired access hole. Connect power cable to housing with appropriate UL approved connector. Connect black to black, white to white and green to green or bare wire. Re-install wiring panel and secure with screw from parts bag.

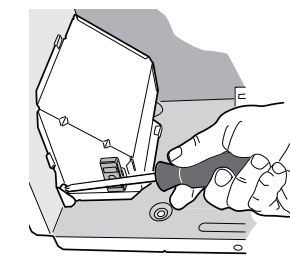
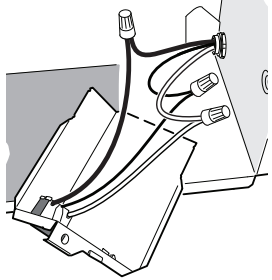
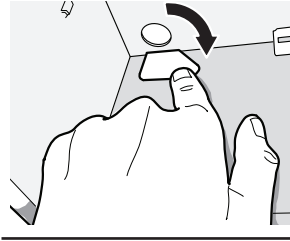

5. Connect wiring.

Bend tab to expose desired access hole. Connect power cable to housing with appropriate UL approved connector. Connect black to black, white to white and green to green or bare wire. Re-install wiring panel and secure with screw from parts bag.

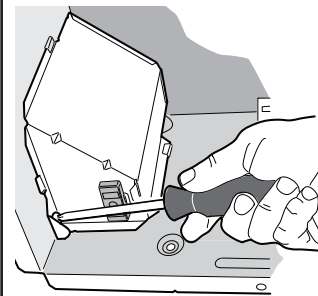
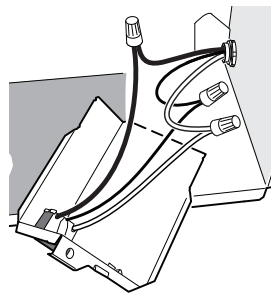
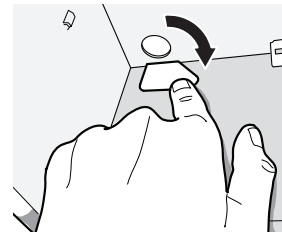

7. Finish ceiling - then skip to Step 8.

RETROFIT INSTALLATION

3. Remove old fan and prepare ceiling.

Existing fan housings are typically attached to the structure:

- with screws, nails, or staples, which must be removed.
- with hangers or rails which are fastened to joists and must be removed along with housing.

A pry bar may be needed to remove the old housing.

Enlarge ceiling opening (if necessary) to 9¼" parallel to joist by 10½" (perpendicular to joist). (Some models have a cut-out template on side of carton.) Leave ductwork and wiring in place.

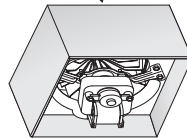
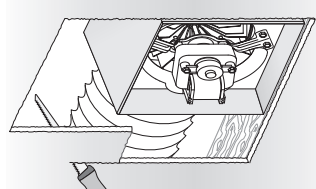
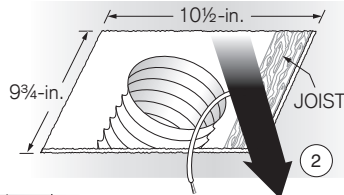

4. Fold mounting ears flat against housing.

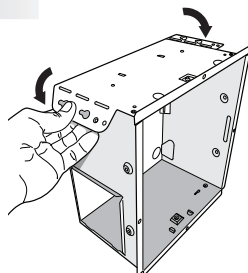

6. Mount fan to ceiling structure.

Mount housing to ceiling structure with standard drywall or wood screws in locations shown. (Some models include mounting screws.)

*Center hole optional.

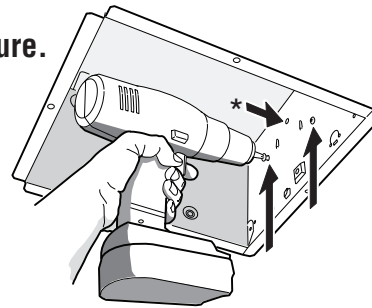

7. Connect 4-in. round duct.

Pull existing ducting through housing discharge opening and tape ducting to duct connector. Push connector/ducting back through opening. Engage tabs and secure with screw from parts bag.

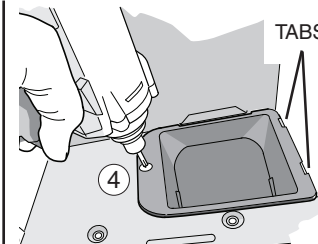
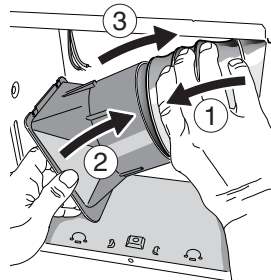

8. Install blower.

Re-install blower removed in Step 1. Secure blower with 2 screws from parts bag and plug blower into black receptacle.

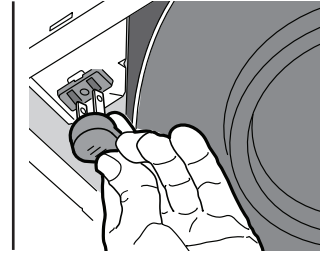
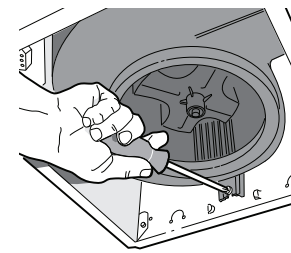

9. Install grille.

Squeeze grille springs and insert into slots in housing. Push grille up against ceiling.

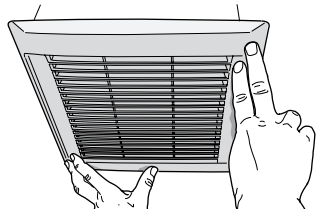
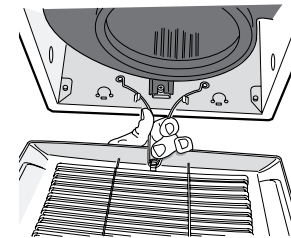

Depending upon model - your grille may look different.

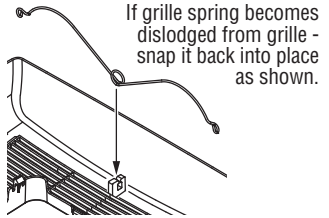

WIRING DIAGRAM

