

Built-In Electronic Chime

MODEL: LA-174

INSTALLATION HINTS

- This Door Chime is recessed into the wall. The white louvered grille is flush-mounted to the wall surface and may be painted.
- **IMPORTANT:** If the door chime is connected to a NuTone Radio-Intercom System, the chime tones will be heard at all inside and outside speaker locations (chime will not sound at door speaker). The Door Chime must be wired in accordance with the Chime-To-Intercom information that is included in this literature.
- If a NuTone Radio-Intercom System is not used, a door speaker may be installed at the outside of the front door so chime tones will be heard at that location.
- Use the NuTone transformer that has been supplied with the door chime.

LOCATION

- Select a central location so the door chime will be heard throughout the house.
- Select pushbutton location(s). This door chime can accommodate up to three (3) door operations.

MOUNTING THE CHIME

Required cutout dimensions: 5 $\frac{3}{8}$ " wide x 7 $\frac{1}{4}$ " high.

Housing: 2 $\frac{1}{4}$ " deep

Refer to Figure 2. Locate wall stud and prepare wall opening at desired location.

WIRING

IMPORTANT: Be certain all wiring complies with local and state codes.

Disconnect the house power when installing the transformer. Keep electricity off until all wire connection have been made.

When securing the wiring to wall studs or ceiling joist, avoid possible shorts that may occur if staples or clips penetrate the protective wiring insulation.

1. Mount the supplied transformer to any junction or panel box. Connect the white and black wires from the transformer to the matching colors of house supply wires. Use approved wire connectors to make all connections.
2. **Refer to Figure 1.** Run 18-2 gage wire from the transformer and pushbutton(s) to the chime location.
3. If applicable, run NuTone IW-2 cable (No.22 twisted pair) from the intercom master station to the chime location.
4. If applicable, run NuTone IW-2 cable (No. 22 twisted pair) from remote speaker(s) to door chime location.
5. Pull wires through knockout in housing. Position the housing flange flush to the finished wall surface and carefully secure the housing with screws. **CAUTION:** The printed circuit board is fragile; DO NOT use nails or hammer.

MAKING CONNECTIONS

1. **Refer to Figure 1.** Make wire connections to terminals shown as applicable.
2. Upon completion of installation, check whether chime is functioning properly by pressing each door pushbutton, if the chime does not operate, recheck your installation and the pushbutton(s) for poor contact or loose connections.

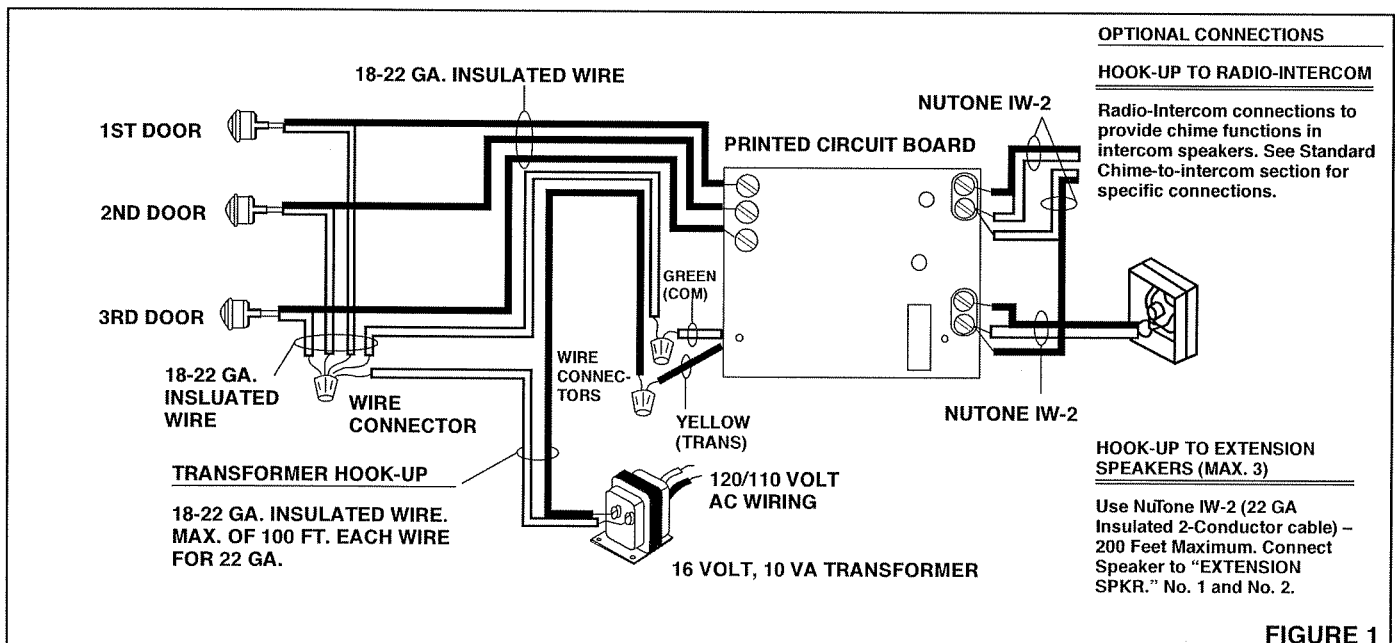

FIGURE 1

CHIME OPERATION

The pushbutton located at the front door will sound eight (8) notes of the Westminster chime sequence. The second door will sound one (1) note and the third door will sound two (2) notes.

VOLUME ADJUSTMENT

Refer to Figure 1.

NOTE: If the chime is being used with the Intercom System, be certain the intercom is on when adjusting the volume of the door chime.

The chime should be heard clearly through the intercom system. If necessary, use a screwdriver to adjust the appropriate volume control on the back of the chime.

Note: The chime volume control also affects the volume of the "INTERCOM OUT" terminals.

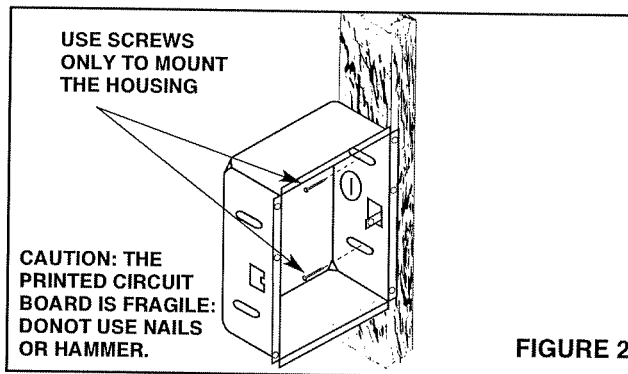

FIGURE 2

STANDARD CHIME-TO-INTERCOM CONNECTIONS

Inside and/or Outside Speakers will receive chime tones (chime will not sound at door speaker); the chime tones will override radio and intercom operation.

INTERCOM CONNECTION	CHIME-TO-INTERCOM CONNECTION
IMA-516	"I-COM 1 & 2" terminals to "CHIME" terminals
IM-2003, IM-3003, IM-4006, IM-3103	"I-COM 1" terminals to "WHITE" "EXT. SPKR. 2" terminals to "BLACK"
IM-3303	WHITE lead of IW-2 cable to "EXT. SPKR. 2" on the chime. GRAY lead of IW-2 cable to "I-COM" on the chime. WHITE lead of IW-2 cable from the chime to (-) "ELECTRONIC CHIME" terminal of IM-3303 Master. GRAY lead of IW-2 cable from the chime to (+) "ELECTRONIC CHIME" terminal of IM-3303 Master.
IM-4406	WHITE lead of IW-2 cable to "EXT. SPKR. 2" on the chime. GRAY lead of IW-2 cable to "I-COM" on the chime. WHITE lead of IW-2 cable from the chime to (-) "ELECTRONIC CHIME" terminal (located next to "line Output Jack" terminal) on the back of IM-4406 Master. GRAY lead of IW-2 cable from the chime to (+) "ELECTRONIC CHIME" terminal (located next to "tape Input Jack Terminal") on the back of IM-4406 Master.
IM-5000	WHITE lead of IW-2 cable to "EXT. SPKR. 2" on the chime. GRAY lead of IW-2 cable to "I-COM" on the chime. WHITE lead of IW-2 cable from the chime to (-) "ELECTRONIC CHIME" terminal (located next to "Door Speaker" terminal) of IM-5000 Master. GRAY lead of IW-2 cable from the chime to (+) "ELECTRONIC CHIME" terminal (located next to circuit board mounting screw) of IM-5000 Master.

NuTone®

One Year Limited Warranty

WARRANTY OWNER: NuTone warrants to the original consumer purchaser of its products that such products will be free from defects in materials or workmanship for a period of one (1) year from the date of original purchase. **THERE ARE NO OTHER WARRANTIES, EXPRESS OR IMPLIED, INCLUDING, BUT NOT LIMITED TO, IMPLIED WARRANTIES OF MERCHANTABILITY OR FITNESS FOR A PARTICULAR PURPOSE.**

During this one year period, NuTone will, at its option, repair or replace, without charge, any product or part which is found to be defective under normal use and service. THIS WARRANTY DOES NOT EXTEND TO FLUORESCENT LAMP STARTERS OR TUBES, FILTERS, DUCT, ROOF CAPS, WALL CAPS AND OTHER ACCESSORIES FOR DUCTING. This warranty does not cover (a) normal maintenance and service or (b) any products or parts which have been subject to misuse, negligence, accident, improper maintenance or repair (other than by NuTone), faulty installation or installation contrary to recommended installation instructions.

The duration of any implied warranty is limited to the one year period as specified for the express warranty. Some states do not allow limitation on how long an implied warranty lasts, so the above limitation may not apply to you.

NUTONE'S OBLIGATION TO REPAIR OR REPLACE, AT NUTONE'S OPTION, SHALL BE THE PURCHASER'S SOLE AND EXCLUSIVE REMEDY UNDER THIS WARRANTY. NUTONE SHALL NOT BE LIABLE FOR INCIDENTAL, CONSEQUENTIAL OR SPECIAL DAMAGES ARISING OUT OF OR IN CONNECTION WITH PRODUCT USE OR PERFORMANCE. Some states do not allow the exclusion or limitation of incidental or consequential damages, so the above limitation or exclusion may not apply to you. This warranty gives you specific legal rights, and you may also have other rights, which vary from state to state. This warranty supersedes all prior warranties.

WARRANTY SERVICE: To qualify for warranty service, you must (a) notify NuTone at the address stated below or telephone 1/800-543-8687, (b) give the model number and part identification and (c) describe the nature of any defect in the product or part. At the time of requesting warranty service, you must present evidence of the original purchase date.

Date of Installation _____ Builder or Installer _____

Model No. and Product Description _____

IF YOU NEED ASSISTANCE OR SERVICE:
 For the location of your nearest NuTone Independent Authorized Service Center:
Residents of the contiguous United States Dial Free 1-800-543-8687
 Please be prepared to provide:
 Product model number • Date and Proof of purchase • The nature of the difficulty

Residents of Alaska or Hawaii should write to: NuTone Inc. Attn: Department of National Field Service, 4820 Red Bank Road, Cincinnati Ohio 45227-1599.
Residents of Canada should write to: Broan-NuTone Canada, 1140 Tristar Drive, Mississauga, Ontario, Canada L5T 1H9.

Rev. 03/2001